

INSTALLATION AND PROGRAMMING

Phasefale's TC1

INDEX

1. Installation
2. Programming
 - 2a. Advanced Programming Options
 - 2b. A Programming Example
3. Cooling and Heating Operations
4. Alarm
5. Defrost
6. Temperature Logging
7. Alphabetical Table of Indications
8. TC1 Wiring Diagram

General Overview and Introduction

Phasefale's TC1 is a single stage (on/off) temperature controller with defrost capabilities and is simple to set up and operate. The temperature is shown on the LED display. If cooling or heating operations are occurring a point is displayed at the end of the temperature display. During defrost, **dF** is displayed. The programmed settings may be viewed by pressing and holding the **M** button for 2 seconds. A (display only) temperature alarm is indicated by the flashing of the temperature display.

The TC1 is a simplified version of the TACm control which includes sophisticated alarm facilities in addition to the control capabilities of the TC1 detailed here.

1. INSTALLATION

Enclosure Installation

The Enclosure can be mounted in any position, and is splash proof. Mount the base and fit two of the mounting screws in the lid. The lid can then be hinged out to allow the electrical connections to be made.

Temperature Sensor (M Probe) Installation

The temperature sensor is an NTC thermistor of extreme accuracy (0.2°C), and it has a non-linear resistance-temperature characteristic (see chart below). It is ideally mounted in a position where refrigerated air is circulating.

At least 150mm of the sensor cable needs to be in the refrigerated space to ensure accurate temperature sensing.

If the sensor cable is open or short circuit, the TC1 will display **Er** to indicate the fault.

The sensor cable is double insulated and therefore does not need to be enclosed in a conduit. There is no polarity to the sensor connection. It may be extended up to 100 metres by joining an extra cable (use double insulated cable) *but* the join must be well insulated and away from any dirt or moisture.

Dirt or moisture at the join will reduce the resistance of the probe and result in

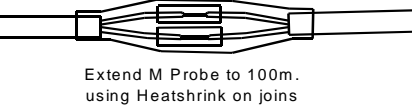
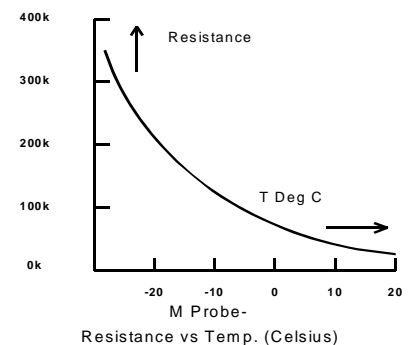

a higher temperature reading than normal.

Electrical Installation

Refer also to the electrical wiring diagram for connection details. The Active supply to the unit should be fused with a maximum rating of 10A. The control output is rated at 10A resistive. **Motors larger than 1 HP MUST be switched via a relay or contactor** (available from Phasefale).

If the **mdPCB** option for heater and fan outputs is to be fitted, follow the instructions supplied with it.

TC1 is not supplied with a **comprog** interface.

Installation Self-Test

Press **M** and **S** together for 5 seconds. The TC1 automatically cycles its outputs in the following sequence:

Display	Action	sec.
CO/CF	Control On&Off	10/4
LO/LF	nil	4/4
dO/dF	nil	4/4
HO/HF	Heater On&Off	4/4
FO/FF	Fan On&Off	4/4

2. PROGRAMMING

The basic programming steps are:

- "Unlock" the TC1 permanent memory for programming
- Select the setting to be adjusted.
- Alter the setting to your desired value.
- Store the changed value.
- Return to normal operation.

a) To unlock the TC1 and alter the settings, press **M** and **S** together for 5 seconds. **UL** will be displayed to indicate that the system is unlocked.

b) After the TC1 is unlocked press **M** until the setting you wish to alter is displayed. The settings and values are displayed in the table below:

Setting	De-fault	Display adjustment range
SP	0.0	Control Setpoint °C (-35 ~ +55°C)
dI	Ec	Differential Temp °C 0.5~5°C, Ec: economy
AH	13	High Alarm Temp. °C (-30~ +60°C)
AL	-5.0	Low Alarm Temp. °C (-40~+50°C)
At	90	Alarm Time Delay (0~99 minutes)
nd	1	Number of defrosts per 24hr (0~6)
dd	30	Defrost duration (1~99minutes)

c) After the setting to be adjusted is displayed, you can increase or decrease the setting by pressing **+** or **-** until the numerical value required is displayed.

d) To store the changed value, press the **M** keypad. The new value is now stored indefinitely and will remain during power loss.

e) If no keypad is pressed for 60 seconds the TC1 will once again lock itself and further alterations will be disallowed until unlocked again. This will also occur if the **S** key is pressed during the programming operation.

Remember! you must store each altered value using **M**

2a. ADVANCED [AAMenu] PROGRAMMING OPTIONS

A further series of functions and commands can be accessed during the

Unlocking stage by simply pressing the **MF** and **ON** keys for a total of 10 seconds, at which time the symbol **AA** is displayed. Program items which can be accessed in the advanced menu are indicated in the following table and are explained under their appropriate function headings.

Setting	Default	Value Shown (adjustment range)
AA	14	Alarm Acknowledge/ Limit Start Time
tr	5 *	* not applicable to this model
Co/He	Co	Cooling or heating mode
dt	1	Heater drain period (0~12minutes)
Ft	1	Fan delay/ Pump down time (0.0~4.0 min.)
dE/dg	dE *	Electric or Hotgas defrost (electric only available)
tE/rA	tE*	* not applicable to this model
Sd/Hd	Sd	Show/Hide temperature display during defrost
St	3	Time of first defrost (0~23)
CA	0.0	Calibration Offset (-9.9 to 9.9°C)

2b. A PROGRAMMING EXAMPLE

A small fruit room needs to be controlled at 1.0°C. We want a high alarm at 9.0°C and a low alarm at -2.0°C to indicate out of range conditions. Being a small room, we will set the alarm time to 60 minutes. As we are energy conscious, we will use the economy mode of operation. We want two 45 minute defrosts per day.

Step 1 Use the auto-setup to load suitable settings:

- Unlock the TC1 using **MF** and **ON** keys. Display reads **UL**, then...
- Display shows **SP** eg. 5.0.
- Decrease the setpoint by pressing **DOWN** until 1.0 is displayed.
- Store the new setpoint with **MF**.
- **dl** (for differential) then **Ec** (Economy mode *) is displayed.
- Press **DOWN** and **AU** (Automatic mode *) is displayed.
- Store the automatic setting with **MF** key.

* There are three programming options in differential **dl** :

Ec Economy mode - a method to reduce energy usage whilst using the

internal limit start timer to protect the compressor.

AU Auto setup - Default settings (for all the programmable values) based on your setpoint are loaded into the TC1's memory.

0.5 to 5.0 Differential Temperature in °C - The specific temperature required for the control. (See Cooling and Heating Operations)

Step 2 The TC1 has stored close values, but we now "fine tune" the settings for our application:

- Unlock the TC1: **MF** and **ON**
- Display **UL**.
- **SP** then 1.0 is displayed, press **MF**
- **dl** then **EC** is displayed, press **MF**.
- **AH** then 14 is displayed, decrease the high alarm to 9.0 using **DOWN** Store the new high alarm setting with **MF**.
- **AL** then -4.0 is displayed, increase the low alarm setting to -2.0 using **DOWN**
- Store the new low setting using **MF**
- **At** then 90 is displayed, decrease the alarm time delay to 60 using **DOWN**, then store with **MF**.
- **nd** then 1 is displayed. We want 2 defrosts so press **DOWN** then **MF** to store.
- **dd** then 30 is displayed, set the defrost duration to 45 and store with **MF**.

Step 3 Check our Settings

Press **MF** for 2 seconds, and our stored values are automatically displayed. The TC1 is now ready for operation.

3. COOLING AND HEATING OPERATIONS

Heating and cooling control is between the setpoint **SP** (cut in) and the setpoint minus the differential **dl** (cut out). For example: **SP** = 10°C, **dl** = 1.0°C: control between 9.0°C and 10°C. Another example: **SP** = -10°C, **dl** = 3.0°C: control between -10°C and -13°C.

The Heating and Cooling options **HE** and **Co** [AA menu] select whether the C1/C2 output controls heaters or coolers. In heating mode there is no limit start timer or defrost function and programming options which relate to defrosts will be skipped. If Cooling is selected, a limit start timer protects against short cycling the compressor. The timer will prevent the cooling output turning on for a period starting

the previous time the cooling output turned on. Once this period has elapsed the output is free to turn on as required. The limit start period is the units part of the **AA** (alarm acknowledge) setting. For example **AA**=4,14,24 etc. means a limit start period of 4 minutes, **AA**=9,19,29,39 etc. means 9 minutes, **AA**=10,20,30 etc means 0 minutes or no limit start delay.

C1/C2 comes on when cooling is required.

The terminate/range temperature function **tE/rA** referred to in programming is not available in the TC1 model.

4. ALARM

Where alarm lights, buzzers and connection to a dialler system is required, the TACm model should be used.

The Alarm function has a high temperature (in °C) setpoint, **AH**, a low temperature (in °C), **AL**, and a time delay, **At**. If either setpoint is exceeded for longer than the time delay an alarm will occur, indicated solely by the display flashing. If cooling mode is selected the low alarm will occur in 1/4 of the time delay **At**.

An Alarm Memory is shown by the display flashing but the temperature has returned to normal limits. In this situation, an alarm has occurred but the temperature has since returned to normal operating limits. It may be cleared by pressing the **ON** button.





5. DEFROST

The defrost duration **dd** is the time in minutes in which the refrigeration is switched off and the heaters are on. Defrosts are spaced at equal periods during the day and the number per day is set by **nd**. For example, if **nd** = 2 a defrost will occur every 12 hours.

A 24 hour clock sets the time of day for defrosts.

Press **DOWN** to find out when the next defrost will occur, **td** is displayed, followed by the number of hours until the next defrost. Similarly, pressing **DOWN** displays **fd** followed by the number of hours since the last defrost occurred. The decimal place represents 10 minutes, ie 2.4 is 2 hours and 40 minutes.

To initiate a Toggle Defrost, hold the **ON** button for 1 second and either

dF or **Co** will be displayed, to indicate whether the refrigeration is presently in defrost or cooling mode. Press the  button followed by  to initiate a defrost or press the  button followed by  to terminate a defrost.

Further defrost functions can be accessed via [AA menu]. The **Sd** (Show defrost) function alternates the display between **dF** and the temperature during defrosts, whilst **Hd** (Hide defrost) causes the display to show only **dF** during defrost.



Also accessible [AA menu], **St** refers to the Start Time of the first defrost. Defrosts will then occur at periods evenly spaced during the day as set by **nd**.



The Heater Drain Time **dt** [AA menu] sets the period in minutes from the end of the defrost period **dd** until the cooling output is allowed to operate.



The **Ft** Fan Delay Time sets the period in minutes from the end of the drain time when cooling comes on to the time when the fans are allowed to operate. The decimal place represents 10 seconds, ie 1.3 is 1 minute 30 seconds.

The **dE/dg** (Electric/hot Gas defrost) [AA menu] is not available in the TC1 and the default **dE** setting should be used.

6. TEMPERATURE LOGGING

Press both  and  buttons together.

Lo (Logging) is displayed. Pressing  will show the highest temperature in the last hour, continue pressing  and the previous hour's highest is indicated - up to 99 hours.

PL indicates that a power loss occurred. If you wish to know how many hours ago a record was stored, press  and  together to show the hours since the record was made. Once again, pressing  will return you to normal operation.

Repeat the above sequence but press  and the lowest temperatures will be shown.



New! JouleTemp & JouleAlarm (left)

Turbocharged TC1/TACm for expanded capabilities including time/date back data logging, ethernet connectivity (built in!), humidity monitoring and control and much more! If you like the TACm, but need more sophisticated logging and remote access via the internet, check out the new JouleTemp and JouleAlarm controllers from Phasefale. "Drop in" replacements for TACm, these units are the latest in control equipment from Australia's favourite cool room control manufacturer! Check our website below or call Phasefale to find out more about this amazing control. JouleTemp is built to the same high standards as TACm.

7. ALPHABETICAL LIST OF DISPLAY INDICATIONS

	Def		Def		Def
AA Alarm Ack./Limit Start	14	dl Differential °C	Ec	Lo Logging	-
AC AC Mains Failure	-	dO <i>Dialler ON</i>	-	LO <i>Light OFF</i>	-
AH High Alarm temp.°C	13	dt Heater drain time mins	1	n6 software version 5.6	-
AL Low Alarm temp °C	-5	Ec Economy mode	Ec	nd number of defrosts	-
At Alarm time delay mins	90	Er Probe Error(open/short)	-	PL Power Loss	-
AU Automatic setup	-	Fd from last defrost hours	-	rA <i>Range (via pot.)</i>	<i>tE</i>
CA Calibrate	0	FF Fan OFF	-	Sd Show temp during defrost	Sd
Co Cooling mode	Co	FO Fan ON	-	SP Setpoint temperature	0.0
CO Cooling ON	-	Ft Fan delay time mins	1	td time to next defrost hours	-
CF Cooling OFF	-	Hd Hide defrost temp °C	Sd	tE <i>temperature terminate</i>	<i>tE</i>
dd defrost duration mins	30	HE Heating mode	Co	tr <i>defrost termination/range°C</i>	5
dE Electric defrost	dE	HF Heater OFF	-	UL programming unlocked	-
dF Defrost or <i>Dialler OFF</i>	-	H0 Heater ON	-	Indications in italics not applicable to TC1	
dg Gas defrost	dE	LF <i>Light OFF</i>	-	<i>Def is the default setting</i>	

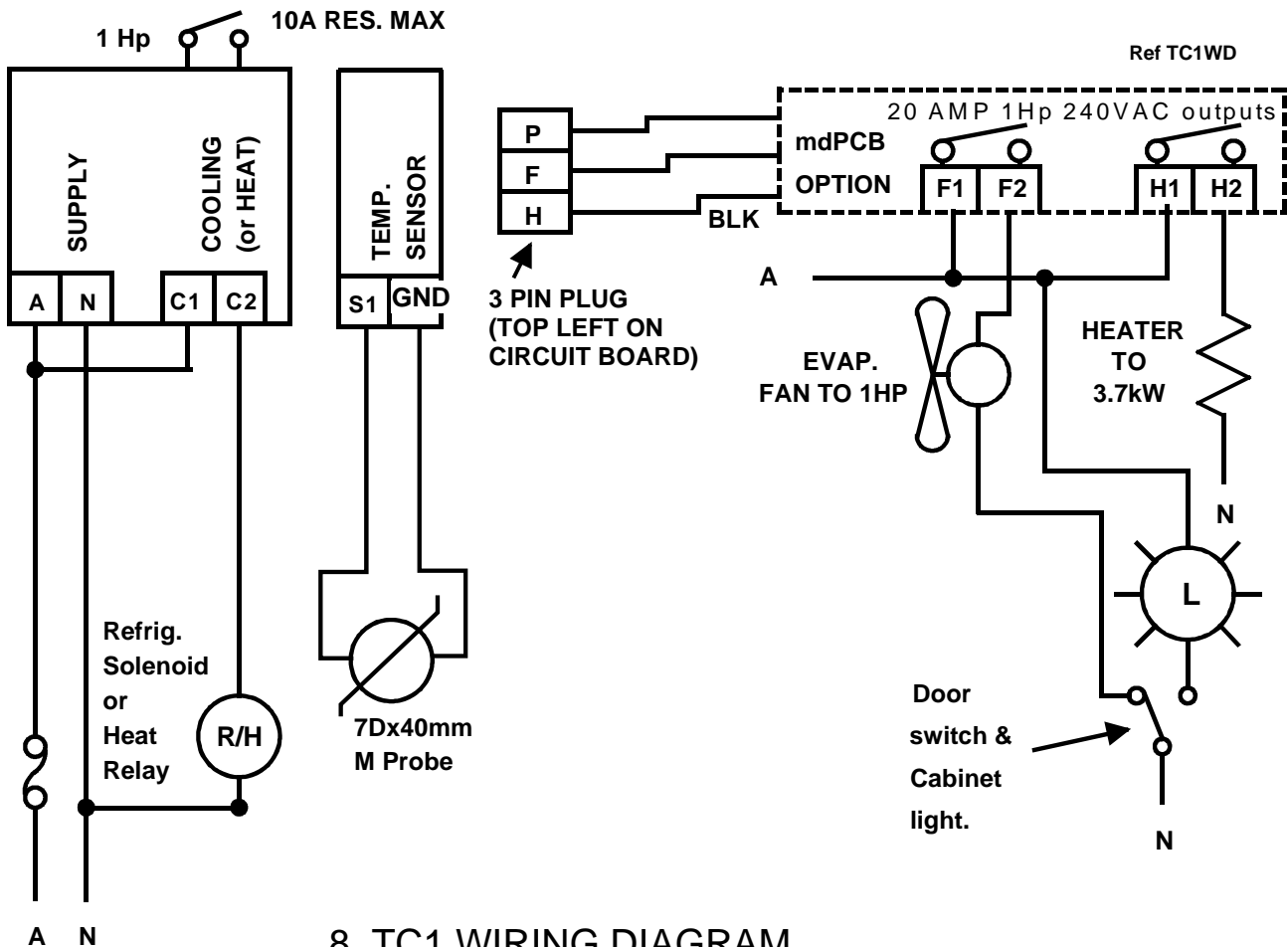

8. TC1 WIRING DIAGRAM

For Technical assistance contact :

PHASEFALE PTY LTD

36 Bulli Street, Moorabbin. Vic. 3189, AUSTRALIA. ACN 078 932 448

Tel (03) 9553 0800 Fax (03) 9553 3993. Intl.Tel +613 9553 0800

www.phasefale.com.au

sales@phasefale.com.au